

PIPER CUB

TUNING PART INSTALATION

Place the aircraft on a flat board (on the side of the wing), the wing must be straight!
 Položte letadlo na rovnou desku (na stranu křídla), křídlo musí být rovné!

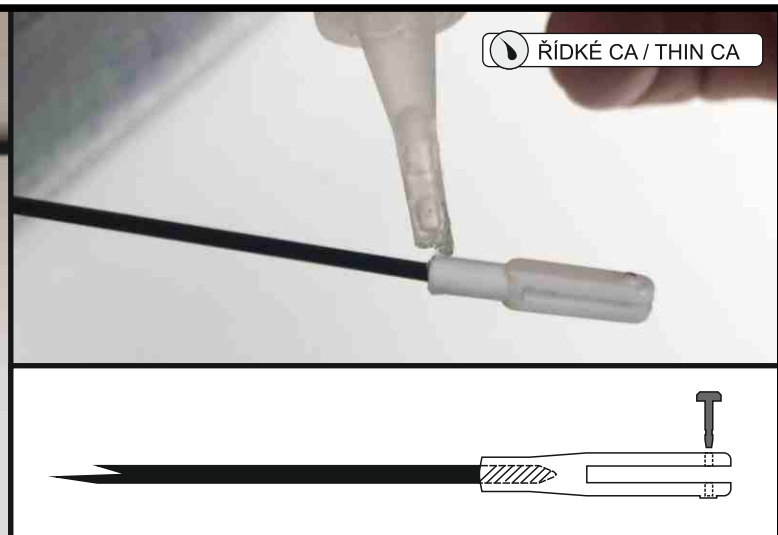

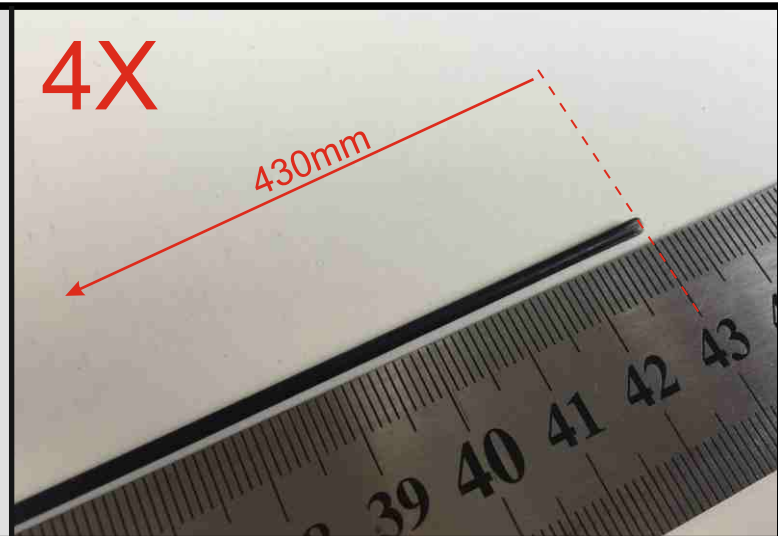
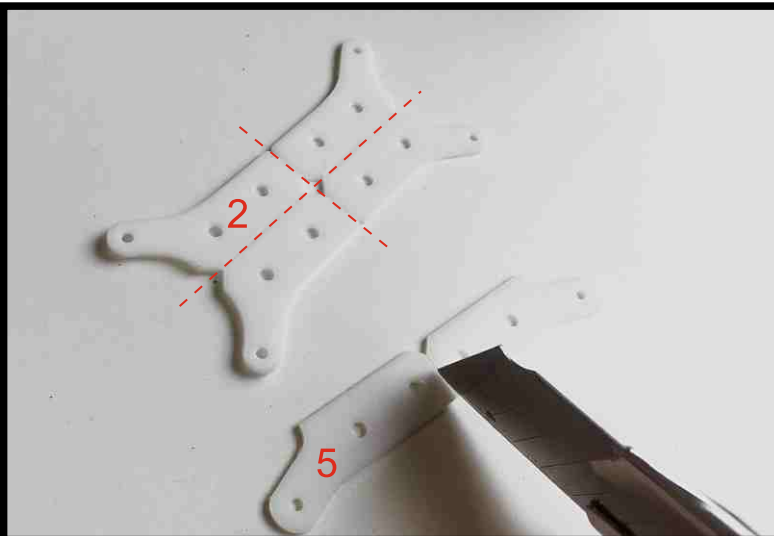
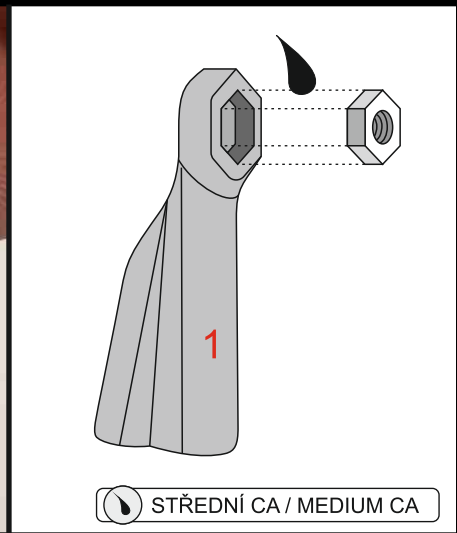
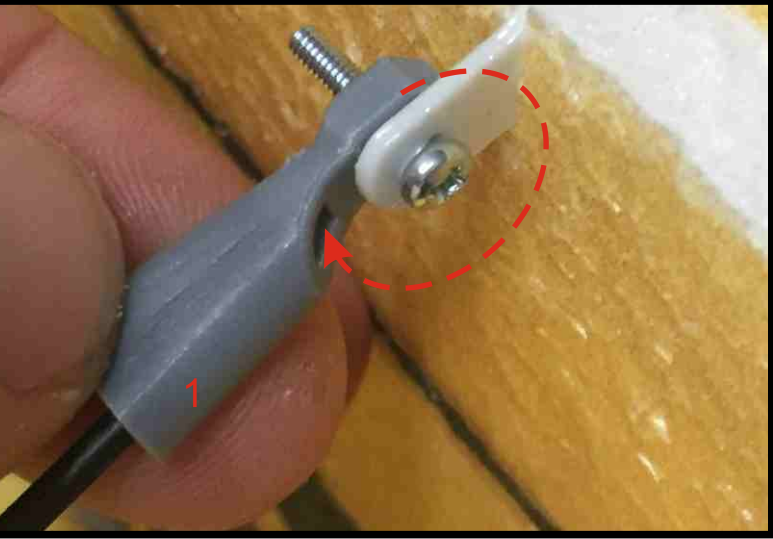
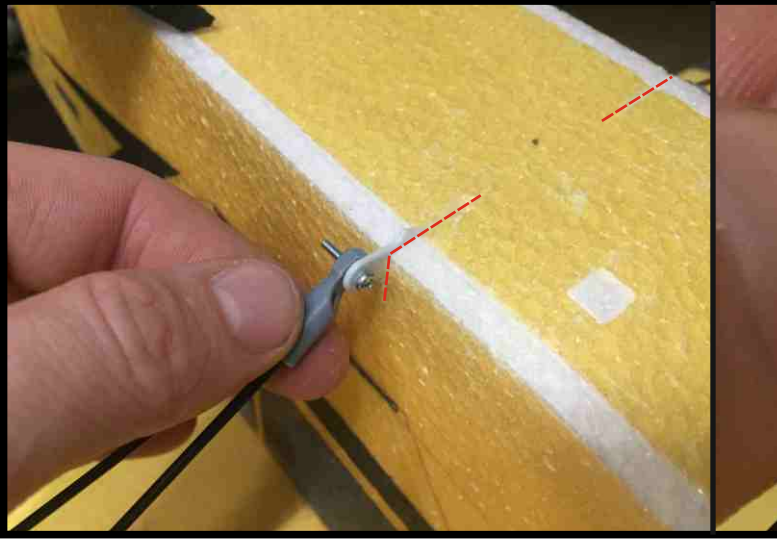
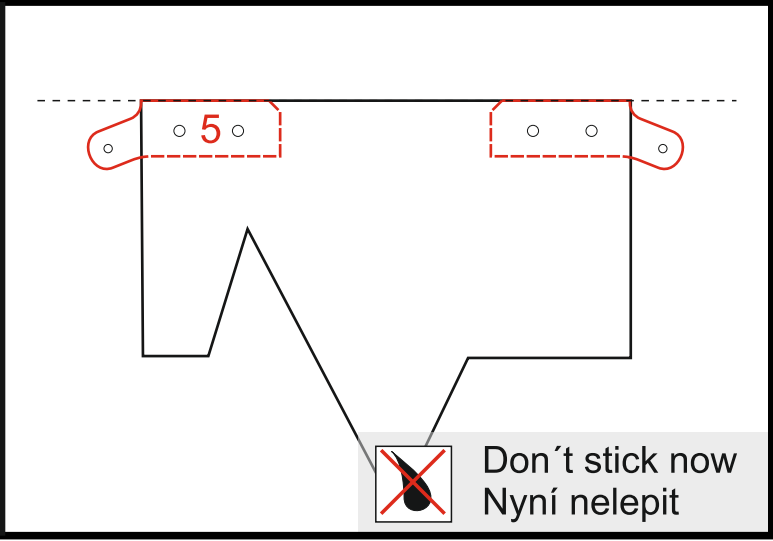
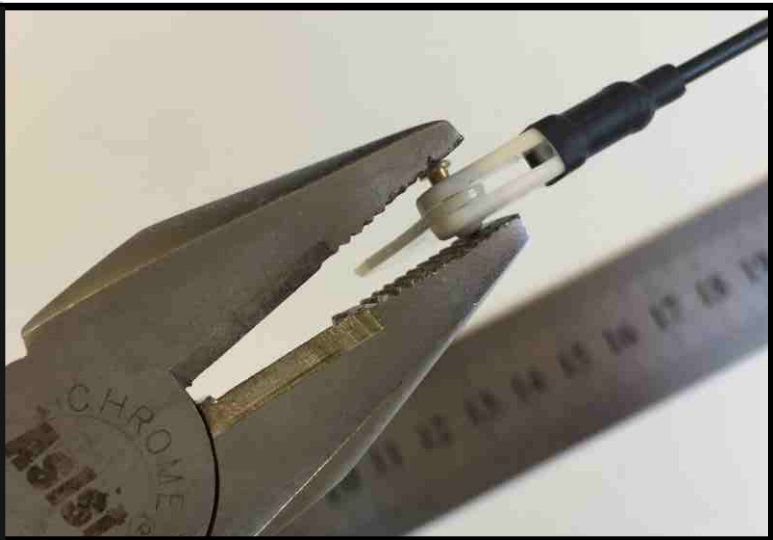
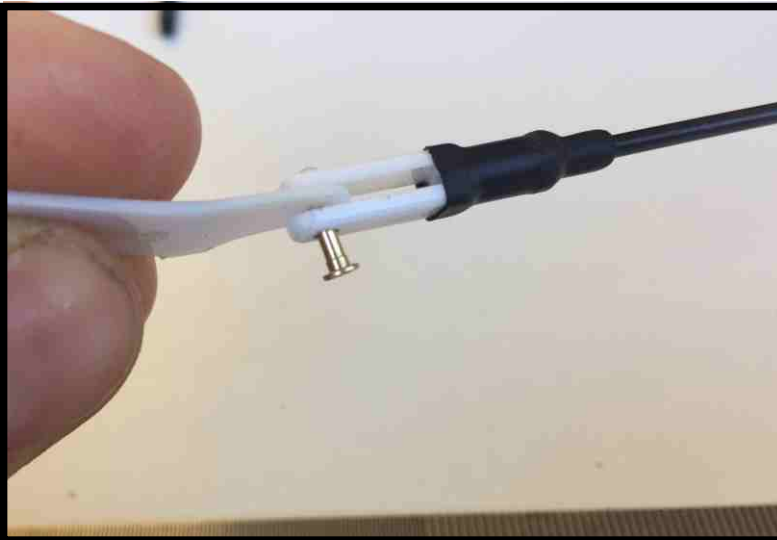
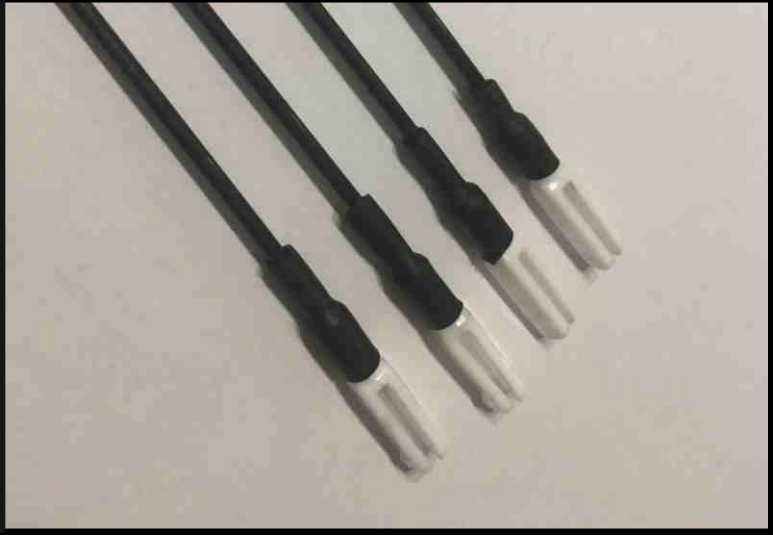

Cut the material for the lever (in the plane of the rod)
Nařízněte materiál pro páčku (v rovině tyčky)

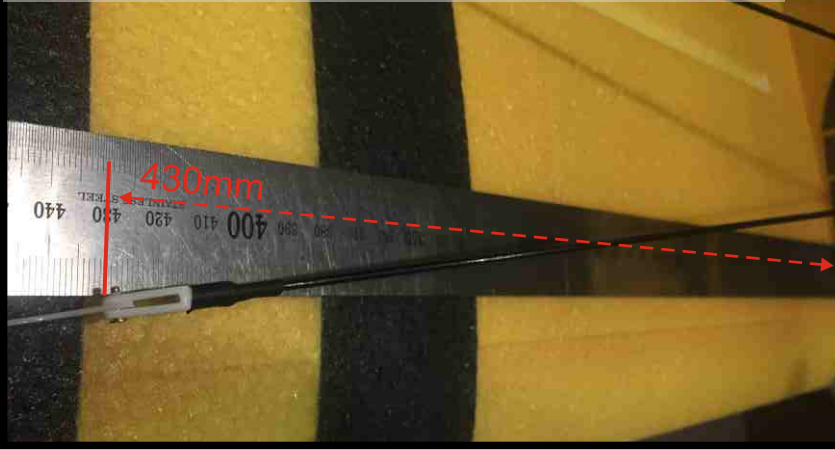

ŘÍDKÉ CA / THIN CA

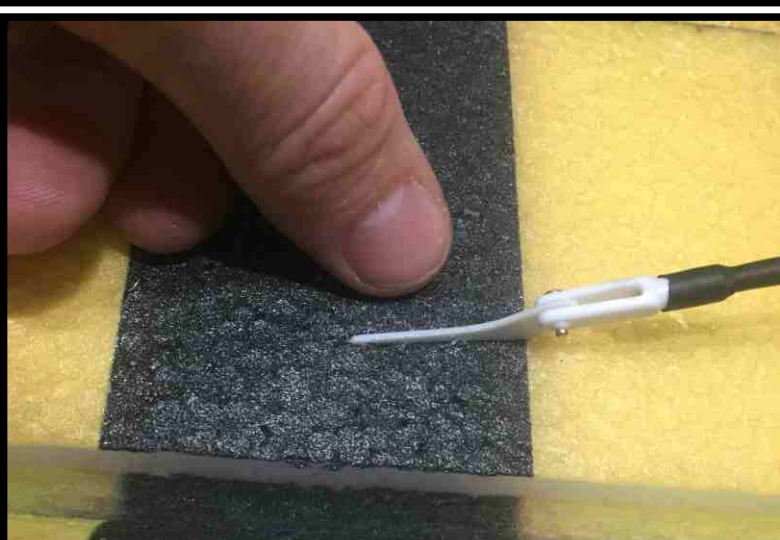
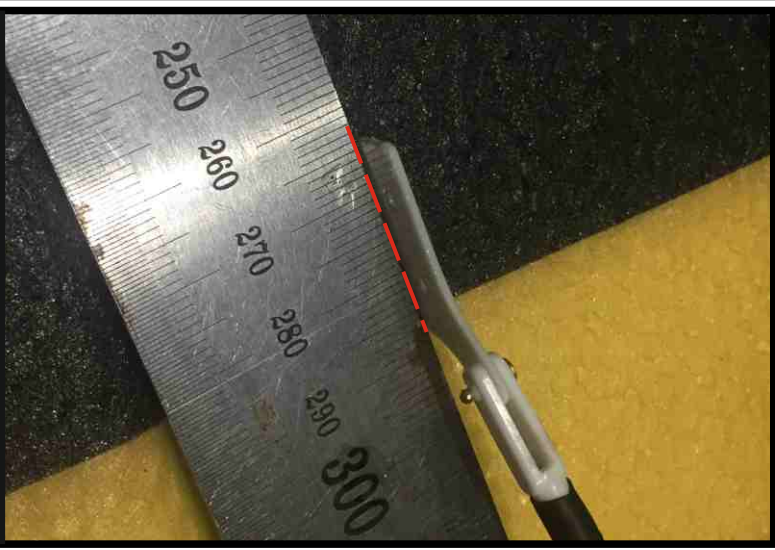
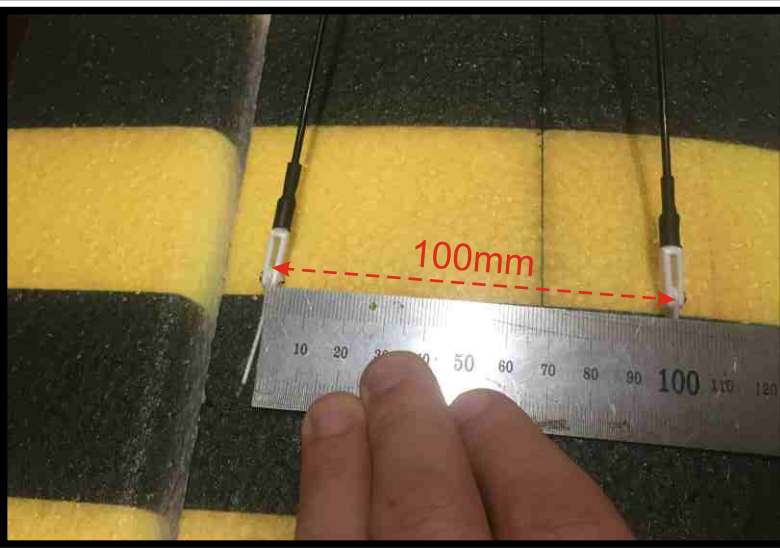

ŘÍDKÉ CA / THIN CA



ŘÍDKÉ CA / THIN CA

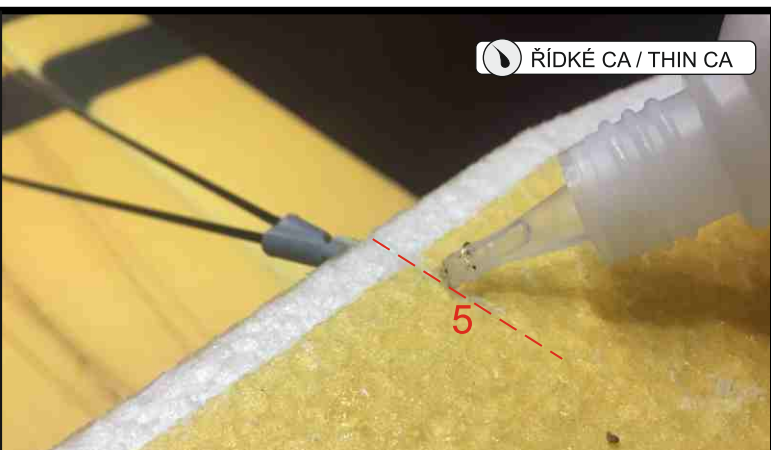

ŘÍDKÉ CA / THIN CA

Make the final check of the wing geometry and now you can glue also these levers (5) to the model fuselage. Proved'te finální kontrolu geometrie křídla a až nyní zalepte i tyto páky (5) do trupu modelu.



STŘEDNÍ CA / MEDIUM CA

